

Data Sheet

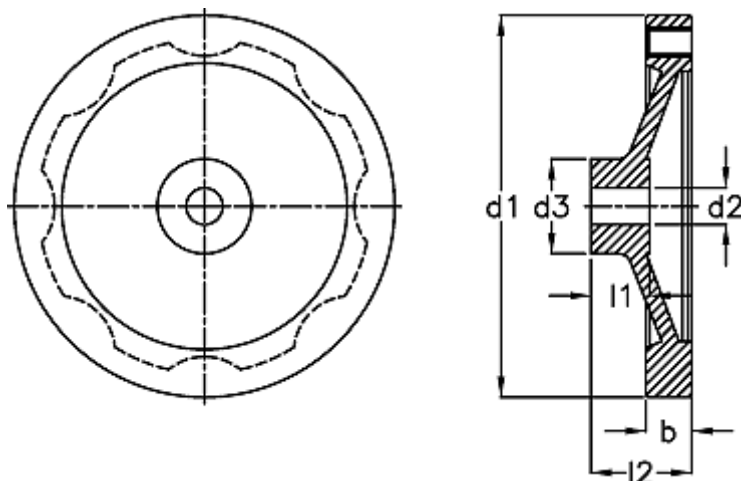

Article number: 20378300
Description: E+G Handwheel
GN 323-125-K14-A

Measures



b	= 15.0
d1	= 125
d2 H7	= 14
d3	= 31
l1	= 18
l2	= 33